

NOVABLADE™ SURFACE MOUNT

LL9P63SK Series Novablade Mounting Accessories



Installation Extras

NovaBlade products are a fantastic light source, and while a majority of applications are in T-bar ceiling systems where they just drop into place, NovaBlade can do much more with the help of specialised mounting frames.

The surface mount provides a tidy solution for concrete slabs and similar situations. It is an attractive enclosure that has ample space to house the driver and the panel. Once the enclosure is mounted, the panel just drops in. For higher security applications optional security screws can be included. Finished protrusion is 50mm.



NovaBlade Flush Mount Frame Features at a Glance

- For mounting onto ceilings where driver cannot be recessed
- Driver fits behind the panels either fixed to the back of the panel or to the base of the mounting frame
- After fixing, the NovaBlade just drops into the frame and self centres
- Safety cables and provision for frame earthing provided
- Provision for security screws to be fitted to prevent unwanted removal of panel
- Seven Year Warranty

Physical

Length: 600mm
 Width: 343mm
 Height: 50mm
 Opening: 597 x 277mm
 Weight: 1.80 kg

Construction

Material: 0.8mm Zinc Anneal
 Finish: White Satin Powdercoat

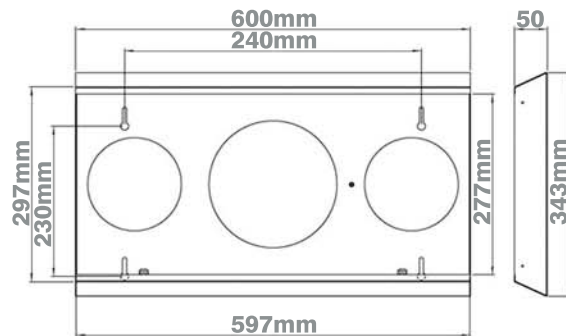

Catalogue Number Guide: NovaBlade Surface Mount

Example: NovaBlade 600mm x 300mm Surface Mounting Frame **LL9P63SK**

Product Group		Group Designation		Frame Size		Mount Fixture Type	
Light Sources	LL9	Panels	P	600 x 300	63	Surface Mount Frame	SK

* October 2016, Specifications subject to change without notice

