

# NOVABLADE™ FLUSH MOUNT

LL9P63FK Series Novablade Mounting Accessories



## Installation Extras

NovaBlade products are a fantastic light source, and while a majority of applications are in T-bar ceiling systems where they just drop into place, NovaBlade can do much more with the help of specialised mounting frames.

The flush mount frame brings the T-bar fit into plasterboard ceilings. It's the neatest way to have great light on hand without a luminaire in sight.

The flush mount frame brings the T-bar fit into plasterboard ceilings. It's the neatest way to have great light on hand without a luminaire in sight. It fits flush with the ceiling and requires as little as 150mm clearance in the ceiling. Once installed, the NovaBlade just drop in as with a T-Bar ceiling grid.



## NovaBlade Flush Mount Frame Features at a Glance

- For flush fitting NovaBlade panels into plasterboard ceiling
- Rigid Aluminium Frame powder-coated in matt white to suit general ceiling colour
- Allows Ease of installation of LUMEX LL9P63 series panels
- Driver secured discreetly behind Panel when mounted in Flush Mount Frame
- Safety cables provided
- Seven Year Warranty

## Physical

Length: 648mm

Width: 348mm

Height: 32mm

Opening: 588 x 288mm

Cut-out size: 610 x 310mm

Weight: 0.65 kg

## Construction

Material: Extruded Aluminium

Finish: White Satin Powdercoat

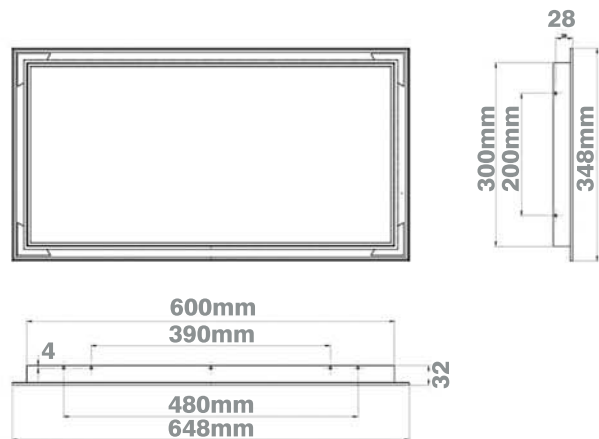

## Catalogue Number Guide: NovaBlade Flush Mount

**Example:** NovaBlade 600mm x 300mm Flush Mounting Frame **LL9P63FK**

Product Group		Group Designation		Frame Size		Mount Fixture Type	
Light Sources	LL9	Panels	P	600 x 300	63	Flush Frame	FK

\* October 2016, Specifications subject to change without notice

