

NOVABLADE™ SEMI FLUSH MOUNT

LL9P126SFK Series Novablade Mounting Accessories



Installation Extras

NovaBlade products are a fantastic light source, and while a majority of applications are in T-bar ceiling systems where they just drop into place, NovaBlade can do much more with the help of specialised mounting frames.

The patented semi-flush mount is for those more awkward places where structural or other considerations make flush mounting impossible. This ingenious product provides a very tidy solution with a protrusion of just 15mm.

Just mount the base, insert the NovaBlade and close the patented sliding gate. The finished result is a protrusion of only 15mm.



NovaBlade Flush Mount Frame Features at a Glance

- For surface mounting NovaBlade panels where the driver can be recessed into the ceiling space
- Quick and easy installation of LUMEX LL9P126 series panels
- After fixing, the NovaBlade is inserted into the frame and secured with sliding gate and locking pins
- Finished result is a protrusion of only 15mm
- Seven Year Warranty

Physical

Length: 1200mm
 Width: 639mm (open), 620mm (close)
 Height: 15mm
 Opening: 1197 x 577mm
 Weight: 4.80 kg

Construction

Material: 0.8mm Zinc Anneal
 Finish: White Satin Powdercoat

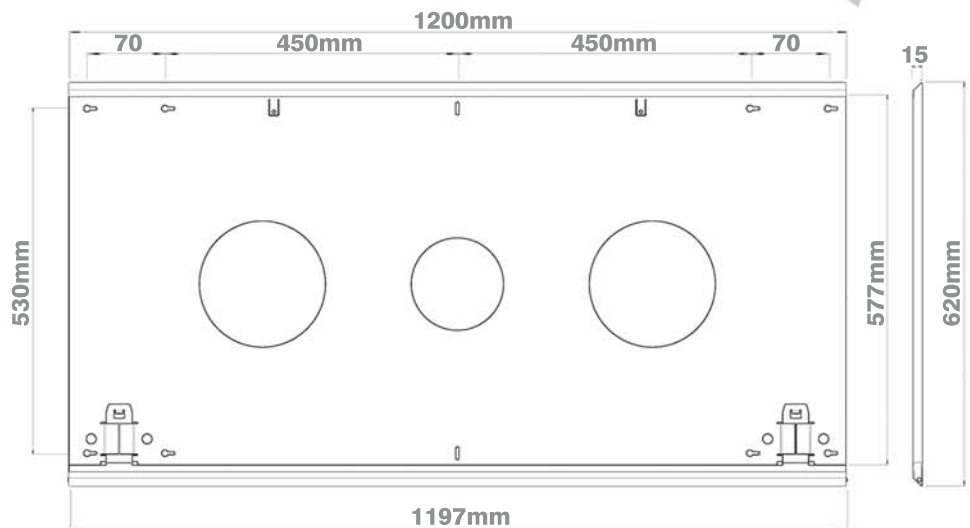

Catalogue Number Guide: NovaBlade Semi Flush Mount

Example: NovaBlade 1200mm x 600mm Semi Flush Mounting Frame **LL9P126SFK**

Product Group		Group Designation		Frame Size		Mount Fixture Type	
Light Sources	LL9	Panels	P	1200 x 600	126	Semi Flush Frame	SFK

* October 2016, Specifications subject to change without notice

