

NOVABLADE™ FLUSH MOUNT

LL9P126FK Series Novablade Mounting Accessories



Installation Extras

NovaBlade products are a fantastic light source, and while a majority of applications are in T-bar ceiling systems where they just drop into place, NovaBlade can do much more with the help of specialised mounting frames.

The flush mount frame brings the T-bar fit into plasterboard ceilings. It's the neatest way to have great light on hand without a luminaire in sight.

The flush mount frame brings the T-bar fit into plasterboard ceilings. It's the neatest way to have great light on hand without a luminaire in sight. It fits flush with the ceiling and requires as little as 150mm clearance in the ceiling. Once installed, the NovaBlade just drop in as with a T-Bar ceiling grid.



NovaBlade Flush Mount Frame Features at a Glance

- For flush fitting NovaBlade panels into plasterboard ceiling
- Rigid Aluminium Frame powder-coated in matt white to suit general ceiling colour
- Allows Ease of installation of LUMEX LL9P126 series panels
- Driver secured discreetly behind Panel when mounted in Flush Mount Frame
- Safety cables provided
- Seven Year Warranty

Physical

Length: 1248mm
 Width: 648mm
 Height: 32mm
 Opening: 1188 x 588mm
 Cut-out size: 1210 x 610mm
 Weight: 1.25 kg

Construction

Material: Extruded Aluminium
 Finish: White Satin Powdercoat

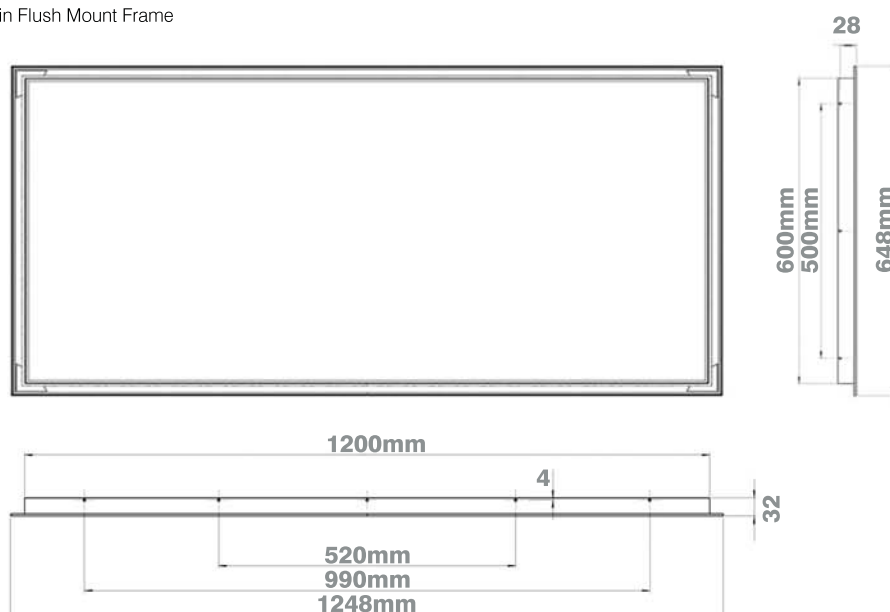

Catalogue Number Guide: NovaBlade Flush Mount

Example: NovaBlade 1200mm x 600mm Flush Mounting Frame **LL9P126FK**

Product Group		Group Designation		Frame Size		Mount Fixture Type	
Light Sources	LL9	Panels	P	1200 x 600	126	Flush Frame	FK

* October 2016, Specifications subject to change without notice

