

Linear-Q™ Generation 2

LL4LQ2W Weatherproof Series LED Battens



Linear-Q Weatherproof Features at a Glance

- Range: 1200Lm, 10W
- Up to 120Lm/W
- LM80 projected LED life > 50,000 hours
- Colour Temperatures: 6500K and 4000K
- Frosted diffuser, Beam angle 120°
- Colour rendering CRI > 80
- Grey Vandal Resistant Body
- Quick-mount clip together assembly
- Corrosion resistant nylon clips
- IP65 Protection rating
- 1-10V dimming capability as standard
- Immune to Ripple Frequency Interference
- Direct connect facility
- Fully recyclable
- Fully Australian Approved
- Seven Year Warranty

Dimming

Linear-Q Weatherproof products are 1-10V dimmable. DALI dimming optional.

Ripple Frequency Interference

Linear-Q Weatherproof products are immune to ripple frequency interference.

Unrivalled Efficiency

Linear-Q Weatherproof products utilise the latest developments in LED and offer among the highest energy to light conversions currently available - up to 120Lm/W.

Environment and Safety

Linear-Q Weatherproof products are fully recyclable with no glass to break, no dangerous chemicals, and no risk from exposed voltages.

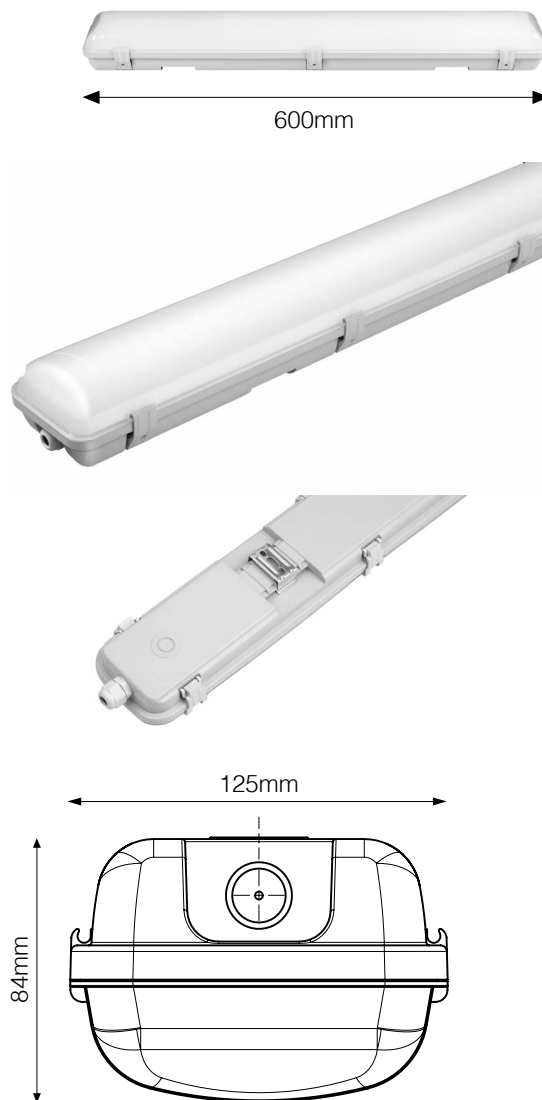

Catalogue Number Guide: Linear-Q Weatherproof

Example: Linear-Q Weatherproof, 600mm, Output Level 1, 120° Beam Angle, 4000K, Grey Fixture **LL4LQ2W61NW**

Product Group	Group Designation			Dimmable		Size		Level		Colour Temperature		Fixture Colour	
Fixtures	LL4	Linear Q Weatherproof	LQ2W	1-10V Dimmable		600mm	6	Single	1	6500K	C6	Grey	
				DALI	DD					4000K	N		



Linear-Q™ Generation 2

LL4LQ2W Weatherproof Series LED Battens



Physical

Length:	600mm
Width:	125mm
Height:	84mm
Mounting Hole Centres:	350mm
Weight:	1.25kg

Control and Programming

Dimming:	1-10V
----------	-------

Construction

Colour:	Grey
Body:	Polycarbonate
Impact Rating:	IK08
Protection Rating:	IP65

Connection

Power Connection:	Direct connection
-------------------	-------------------

Output

Luminous Flux 4000K:	1200Lm
Efficacy:	up to 120Lm/W
Beam Angle:	120°
CRI:	>80

Electrical

Input Voltage:	220-240 Vac
Typical Total Power:	10W
Power Factor:	0.90

Thermal

Storage Temperature:	-40°C to +80°C
Operating Range Ta:	-35°C to +50°C
Humidity (non-condensing):	10-100%

Certificates

EMC:	AS/NZS CISPR15 (C-Tick)
Electrical Safety:	AS/NZS 60598.2.1, AS/NZS 4417 (RCM)

Specifications subject to change without notice.

